

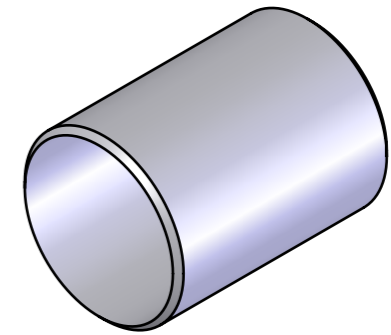

REVISIONS				
ZONE	REV.	DESCRIPTION	DATE	AUTHOR
	A	CREATION	17/04/2013	M. DELBECQ

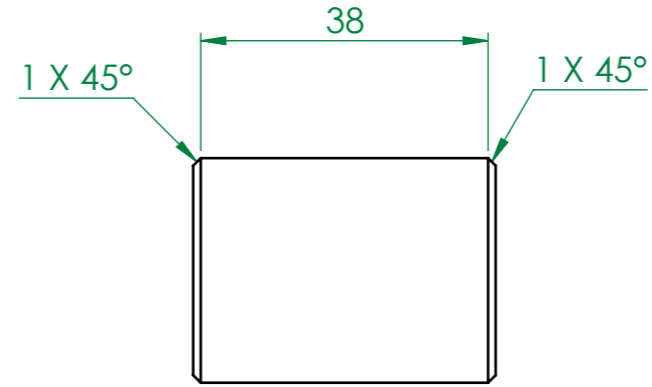
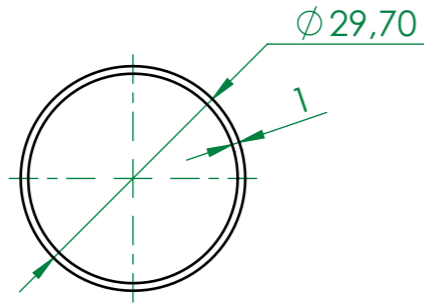

 <p>ZI du prat Rue des frères Mongolfier F-56000 Vannes</p> <p>Tel(33) 02.97.01.08.80 Fax (33)02.97.01.08.81 EMAIL Contact@sigmaphi.fr</p>	Name	Date
	Drawing M. DELBECQ	17/04/2013
	Checked	
	Approved	
	MATERIAL: 304L (X2CrNi18-9)	
	Trait.:	
	Roughness :	
	Tol Gen ±1	
	Supplier:	
	Weight: 0.03 Kg	
	File name:317111-JLA-703-044	
DWG NO. 317111-JLA-703-044	Rev: A	
<p>This drawing may not be used without special licence or authorisation express (Law of the 11 march 1957)</p>		
	 A3	SCALE:1:1 SHEET 1 OF 1