

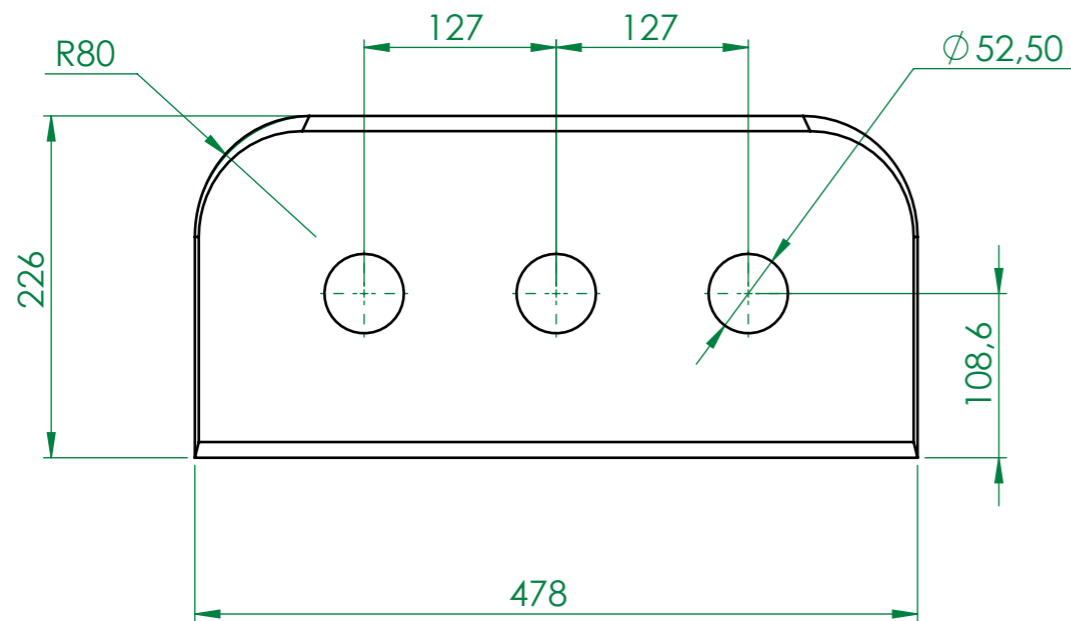

REVISIONS				
ZONE	REV.	DESCRIPTION	DATE	AUTHOR
	A	CREATION	26/08/2013	M. DELBECQ

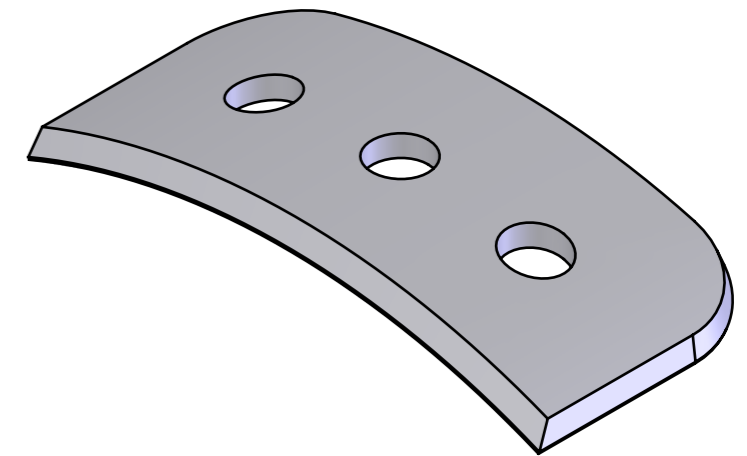
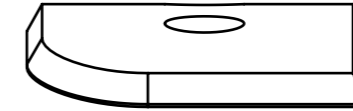
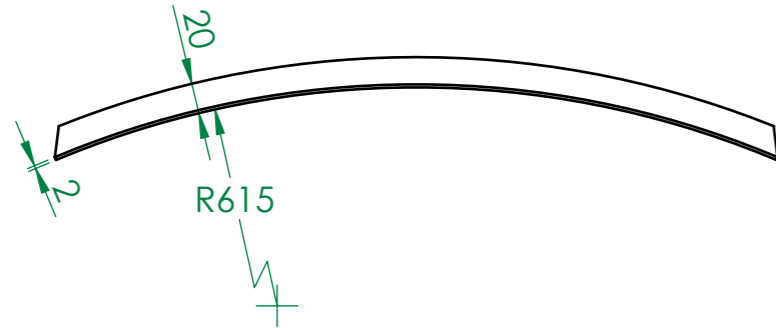

 <p>ZI du prat Rue des frères Mongolfier F-56000 Vannes</p> <p>Tel(33) 02.97.01.08.80 Fax (33)02.97.01.08.81 EMAIL Contact@sigmaphi.fr</p>	Name	Date
	Drawing M. DELBECQ	24/09/2013
	Checked	
	Approved	
	MATERIAL: 304L (X2CrNi18-9)	
	Trait.:	
	Roughness:	
	Tol Gen ±1	
	Supplier:	
	Weight: 15.28 Kg	
	File name:318711-JLA-703-011	
DWG NO. 318711-JLA-703-011	Rev: A	
<p>This drawing may not be used without special licence or authorisation express (Law of the 11 march 1957)</p>		
		A3 SCALE:1:5 SHEET 1 OF 1